

# CLARKE®

## POWER



WARNING: Do not use the generator without reading this manual

## 1050W INVERTER GENERATOR

MODEL NO: IG1100

PART NO: 8877113

## OPERATION & MAINTENANCE INSTRUCTIONS

UK  
CA | CE



ORIGINAL INSTRUCTIONS

DL0724

---

## **INTRODUCTION**

---

Before you use this product, read this manual and follow the instructions carefully. In doing so you will ensure the safety of yourself and others around you, and you can also expect your purchase to give you a long and satisfactory service.

---

## **GUARANTEE**

---

This product is guaranteed against faulty manufacture for a period of 12 months from the date of purchase. Please keep your receipt which will be required as proof of purchase.

This guarantee is invalid if the product is tampered with in any way, or not used for the purpose for which it was intended.

Faulty goods should be returned to their place of purchase, no product can be returned to us without prior permission. This guarantee does not effect your statutory rights.

---

## **ENVIRONMENTAL PROTECTION**

---



Recycle unwanted materials instead of disposing of them as waste. All tools, accessories and packaging should be sorted and taken to a recycling centre for disposed in a manner compatible with the environment.

By purchasing this product, the customer is taking on the obligation to deal with its safe disposal in accordance with the Waste Electrical and Electronic Equipment (WEEE).

In effect, this means that this product must not be disposed of with general household waste. It must be disposed of according to the laws governing Waste Electrical and Electronic Equipment (WEEE) at a recognised disposal facility. If disposing of this product or any damaged components, do not dispose of with general waste. This product contains valuable raw materials. Metal products should be taken to your local civic amenity site for recycling of metal products.

## SPECIFICATIONS

Engine	Engine Model	LY144F
	Type	Petrol
	Displacement (cc)	53.5
	RPM	5000
	Ignition type	Mag
	Fuel tank capacity: Safe Fuel Level (L)	2
	Fuel Consumption at 3/4 Load (L/h)	0.7
	Maximum run time at 3/4 load (h)	Approx. 2h 50m
	Engine oil capacity (L)	0.15
	Emissions (g/kWh) CO, HC, NOx	240.12, 34.84, 1.93
	Guaranteed sound power (LWA dB)	93
Generator	Rated Frequency (Hz)	50
	Rated AC Voltage per 13A socket x 1 (V)	230
	Rated DC Voltage per socket x 3 (V)	2 x 5V USB 1 x 12V Connector
	Rated Output Current @1050W/230V(A)	4.56
	Maximum Rated Output Current (A)	4.3
	Rated Output Power: (Continuous) (W)	1000
	Maximum Rated Output Power (W)	1050
	Output Type	Sine Wave
	Starter Type	Recoil
	Operating Temperatures	-5°C to 40°C
	IP Rating	IP23M
Dimensions	Depth x Width x Height (mm)	405 x 250 x 425
	Unpacked & Unfueled Weight (kg)	13.4

---

# GENERAL SAFETY RULES

---



**WARNING: EXHAUST FUMES CAN BE EXTREMELY DANGEROUS IF INHALED**

---

## WORK AREA

- **ALWAYS** use in a well ventilated area.
- **ALWAYS** position the exhaust outlet away from people.
- Read these safety instructions before using the equipment.
- Keep children away from the generator.

## POSITIONING THE GENERATOR

1. Keep the generator at least 1 m (3 ft.) from buildings or other equipment, or the engine may overheat.
2. Place the generator on a solid, flat surface.
3. Make sure the surrounding area is free from any material that could burn or be damaged by heat.
4. **NEVER** move or tilt the generator whilst it is switched on.

## FIRE PREVENTION

1. **ALWAYS** switch the engine STOP when refuelling.
2. **ALWAYS** refuel in a well ventilated area.
3. **NEVER** overfill the fuel tank only fill to the level specified.
4. **NEVER** smoke whilst refuelling and avoid smoking or using a naked flame near the generator.
5. **NEVER** start the engine if there is spilled fuel. Any spillage must be wiped clean and the generator allowed to dry before attempting to start the engine.

## PREVENTION OF ELECTRIC SHOCK

1. **NEVER** use the generator in the rain or wet conditions unless it is well protected/covered. Under these conditions, adequate ventilation **MUST** be provided.
2. **NEVER** operate the generator with wet hands.
3. **NEVER** use water or any other liquids to clean the generator.









4. Make sure you ground (earth) the generator.

## ADDITIONAL SAFETY RULES FOR GENERATORS

1. **ALWAYS** make sure the applied load does not exceed the generator rating. Overloading the generator is dangerous and could cause serious damage.
2. **ALWAYS** turn off and disconnect any appliance from the generator when carrying out any maintenance.
3. **ALWAYS** allow the generator to reach operating speed before connecting a load.
4. **NEVER** allow the generator to run out of fuel when a load is connected.
5. **NEVER** transport the generator with fuel in the tank.
6. **NEVER** connect the generator to a commercial or residential power supply; e.g. ring main.
7. **NEVER** allow the generator air vents to become blocked.
8. **NEVER** directly cover the generator while in use.

## SAFETY SYMBOLS

The following safety symbols are shown on the product or it's packaging. Please read all of the safety and operating instructions carefully before using this product.

	<b>Read instruction manual before use.</b>		<b>Hot surface - DO NOT touch</b>
	<b>Dangerous Voltage</b>		<b>Poisonous fumes - DO NOT use the generator in an enclosed space.</b>
	<b>Flammable</b>		<b>Caution - The user should be aware of a general hazard.</b>
	<b>DO NOT cover while in operation</b>		<b>Earth Connection Point</b>

## OVERVIEW - CONTROL PANEL



NO	DESCRIPTION	NO	DESCRIPTION
1	Oil Alarm, Overload & Output Indicator Lights	5	2 Pin 12V/5A DC Outlet
2	Economy Control Switch	6	2 x 5V/2.1A USB DC Outlets
3	DC Breaker Reset Switch	7	Earthing Point
4	3 Pin 13A 230V AC Outlet		

## OVERVIEW - GENERAL COMPONENTS



NO	DESCRIPTION	NO	DESCRIPTION
1	Recoil Starter	3	Fuel Cap/Fuel Tank Vacuum Relief Valve
2	Stop/Run/Start Engine Switch	4	Spark Plug Cover

---

## UNPACKING AND ASSEMBLY

---

Unpack your generator and check the following items are present. Should there be any missing or damaged during transit contact your CLARKE dealer.

1 x 1050 Watt Inverter Generator	1 x 12 Volt Crocodile Clip Lead Assembly
1 x Spark Plug Box Spanner with Arm	1 x Oil Bottle & Spout

---

## BEFORE USING THE GENERATOR

---

***IMPORTANT: Generators should ALWAYS be earthed. Make sure you earth the generator.***

Before using your generator check that the generator is:

- In good condition and free from any damage.
- Clean and free from fuel or oil spillage.
- Correctly located for use (see page 4).
- Free from leakage.

**NOTE:** To avoid accidental spillage of fuel, always use a funnel to fill the fuel tank. If fuel is spilled it must be removed from the unit before attempting to start the engine.

## EARTHING



**WARNING: IT IS ADVISABLE TO PROPERLY EARTH YOUR GENERATOR BEFORE STARTING, USING A WIRE AND A SMALL METAL EARTH SPIKE. THE WIRE AND EARTH SPIKE ARE NOT SUPPLIED WITH THIS UNIT.**

An earth rod and cable can be purchased at your local camping or electrical supplier, or alternatively an earth rod can be made, and it is suggested you get advice from a qualified electrician.

The cable used should be insulated and a maximum length of 1 metre and a minimum of 1.0mm<sup>2</sup> to carry a 10amp load.



Attach the cable to the generator at the earthing point (shown on the right).

Connect the other end of the cable to a steel or copper earth rod. If you have purchased a rod, make sure you connect it in accordance with the installation instructions supplied with the rod.

When pushing the rod into the ground the generator must not be running and it is suggested that the rod is pushed into the ground by at least 100 mm.

Earthing of generators is covered in BS7430:2011. If you have any doubts about this subject consult a qualified electrician.



## CHECKING & ADDING ENGINE OIL

**NOTE:** For a more reliable reading, check the oil level when the engine is cold.

1. Place the generator on a level surface and check the oil level as follows.
2. Remove the access panel located on the side of the generator by unscrewing the two screws at the top.
3. Turn the oil filler cap anti-clockwise and remove from the oil reservoir, wipe the dipstick with a clean cloth.
4. Insert the dipstick back into the oil filler tube and then remove it again.



5. If the oil is below the Min. level on the dipstick, top up the oil reservoir with fresh oil using the oil bottle and spout.

- **DO NOT** fill above the max level mark (0.15 litres)
- We recommend the use of SAE 10W-30 oil in this generator. (CLARKE part number 3050845)

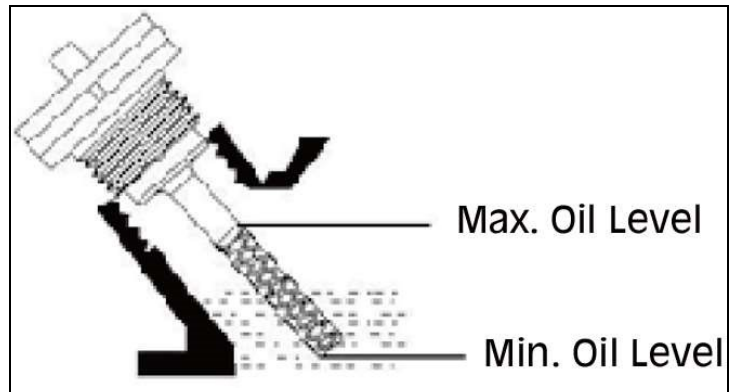

- **DO NOT** tilt the generator when adding engine oil. This could result in overfilling and damage to the engine.

6. Clear up any spillages

7. Replace the oil filler cap.

8. Replace the access panel.

## CHECKING & ADDING FUEL



**WARNING: MAKE SURE THERE IS FUEL IN THE TANK WHEN USING THE GENERATOR. RUNNING OUT OF FUEL OR STOPPING THE ENGINE SUDDENLY WITH A LOAD CONNECTED COULD CAUSE SERIOUS DAMAGE.**

**WARNING: FUEL IS HIGHLY FLAMMABLE AND POISONOUS.**

**WARNING: SEE GENERAL SAFETY RULES ON PAGES 4-5 AND READ THEM CAREFULLY BEFORE REFUELING.**

**WARNING: DO NOT FILL ABOVE THE TOP OF THE FUEL FILTER OR IT MAY OVERFLOW WHEN THE FUEL HEATS UP AND EXPANDS.**

**WARNING: WIPE UP ANY SPILLED FUEL IMMEDIATELY.**

**WARNING: AFTER REFUELING, MAKE SURE THE FUEL FILLER CAP IS TIGHTENED SECURELY.**

### RECOMMENDED FUEL

Your generator has been designed to use regular unleaded petrol with a octane number of 86 or higher.

**NOTE:** The fuel tank capacity is 2 Litres (Safe Fuel Level).

1. Open the fuel cap located on top of the generator.

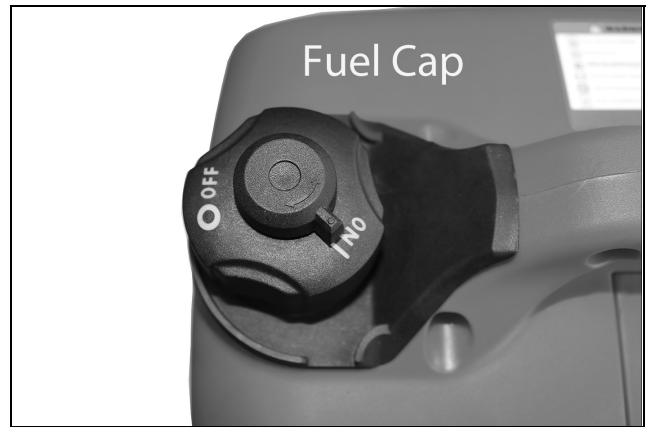

2. Slowly add fuel to the fuel tank, until the fuel level float is at the top of the fuel filter.
  - **DO NOT** overfill the fuel tank. Maximum safe level is 2 litres.
3. Replace the fuel filler cap securely.
4. Clear up any spillages

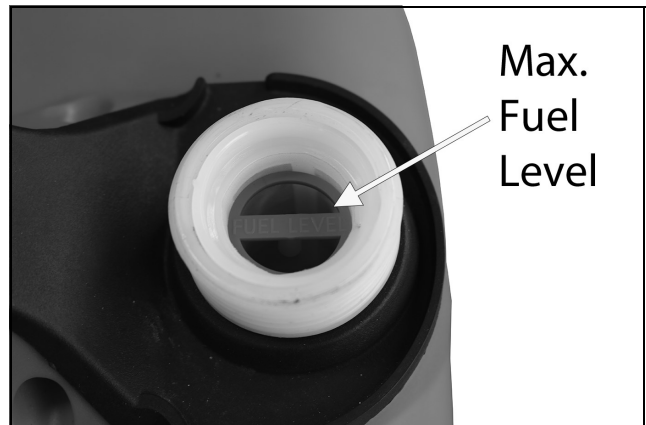

---

## USING YOUR GENERATOR

---



**WARNING: BE SURE TO GROUND THE GENERATOR BEFORE STARTING.**

---

## STARTING THE ENGINE

1. Remove all connections from the AC & DC sockets.
2. Hold the fuel tank cap so that it will not move and turn the fuel tank vacuum relief valve knob to the 'ON' position.



3. Turn the engine switch to the 'START' position.



4. Hold the recoil starter handle firmly and pull lightly until you start to feel resistance and then pull up sharply to start the engine.

**NOTE:** You may have to do this more than once.



**WARNING: ONCE THE GENERATOR HAS STARTED, RELEASE THE STARTING HANDLE SLOWLY TO AVOID INJURY/DAMAGE AS IT CAN WHIP BACK. DO NOT LET THE HANDLE SNAP BACK.**

5. Once the temperature of the engine has increased, turn the engine switch to the 'RUN' position.

**NOTE:** Allow the generator to run for several minutes and the Output light is 'Green' before attempting to connect any electrical devices. This allows the generator to stabilize its speed and temperature.



## ECONOMY (ECO) CONTROL SWITCH

When the Economy Control Switch is turned to 'ON (I)', the engine keeps running at idle state automatically when an electrical appliance is disconnected. It will return to the correct speed with the requirements of an electrical load.

Switching the ECO switch to 'ON (I)' is recommended to minimise the fuel consumption with a load equal or less than 0.5Kw.

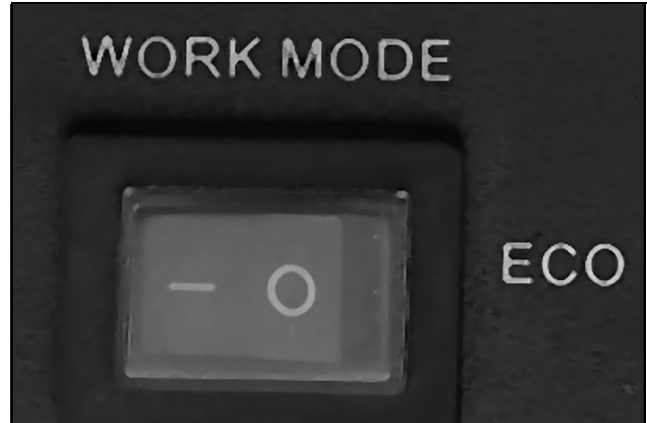

**NOTE:** When a high load electrical appliance (equal or above 0.5Kw) is connected, in order to reduce voltage change, turn the ECO switch to the 'OFF (O)' position.

**NOTE:** In DC operation, turn the ECO switch to the 'OFF (O)' position.

**NOTE:** When in both AC and DC operation, turn the ECO switch to the 'OFF (O)' position.

## CONNECTING ELECTRICAL DEVICES

The generator can supply both 230V AC and 12V DC.

### AC POWER

1. Start the engine, see pages 11-12. Make sure the Output Indicator light is green.
2. Make sure the appliance is turned off before connecting it to the generator.
3. Connect the appliance (max load 1050W) to the generator.



**CAUTION: MAKE SURE THAT THE APPLIANCE BEING CONNECTED IS IN GOOD WORKING ORDER, IF IT BEGINS TO ACT ABNORMALLY OR STOPS SUDDENLY, DISCONNECT IT FROM THE GENERATOR**

**CAUTION: MAKE SURE THE APPLIANCE DOES NOT EXCEED THE MAXIMUM RATED LOAD FOR THE GENERATOR.**

**CAUTION: ANY DEVICE WHICH CONTAINS AN INDUCTIVE LOAD E.G. DEVICES THAT CONTAIN A MOTOR MAY REQUIRE MORE CURRENT ON STARTUP.**

## DC POWER

1. Set the economy switch to 'OFF (O)'.
2. Start the generator, see pages 11-12.
3. Make sure the appliance is turned off before connecting it to the generator.
4. Connect the USB appliance (max 5A) to the generator.



## 12V DC POWER (TOPPING UP CAR BATTERIES)



**WARNING: FOR YOUR SAFETY PERFORM THE FOLLOWING INSTRUCTIONS IN THE ORDER SHOWN.**

**WARNING: YOU SHOULD ONLY USE THIS GENERATOR TO 'TOP UP' THE BATTERY, ALSO TRYING TO CHARGE A COMPLETELY FLAT BATTERY MAY CAUSE THE FUSE TO BLOW.**

1. Set the economy switch to 'OFF'.
2. Start the generator, see pages 11-12.
3. Connect the battery charging leads to the battery.
  - Make sure you clamp the red wire to the positive (+) terminal and the black wire to the negative (-) terminal of the battery.
4. Connect the battery charging leads to the generator.
  - The battery will begin to charge
5. Monitor the voltage across the battery regularly during charging and disconnect the battery when the voltage reaches 14.4 volts.



**CAUTION: WHEN DISCONNECTING THE BATTERY, ALWAYS DISCONNECT THE NEGATIVE LEAD FIRST.**

## INDICATOR LIGHTS

### OUTPUT

The Output Indicator Light (Green) will remain on during normal operation.

### OVERLOAD

If the generator becomes overloaded or the connected appliance short circuits, the Overload Light will turn red, the Output Indicator Light will turn from Green to Red. The power will switch OFF, but the engine will continue running.

If this happens, proceed as follows:

1. Turn off and disconnect any connected electrical devices.
2. Press and Hold the DC Breaker button for at least 5 seconds.
3. If the Output Indicator Light turns from Red to Green, reconnect the electrical appliances.
4. If the Outlet Indicator Light stays Red, stop the engine and check the generator, earthing connection and/or electrical appliance for any problems before attempting to restart.



### OIL ALERT

The oil alert system is designed to prevent engine damage caused by an insufficient amount of oil in the crankcase. Before the oil level in the crankcase falls below a safe limit, the oil alert system will automatically shut down the engine, note the engine switch will remain in the 'RUN' position.

If the oil alert system shuts down the engine, the Oil Alert Indicator Light will turn Yellow/Amber and the engine will not start. To clear the light, check and add oil by following the instructions on pages 9-10

## SHUTTING DOWN THE GENERATOR

To stop the generator in an emergency simply turn the Stop/Run/Start Engine Switch to the 'STOP' position.

**NOTE:** Turn off any electric devices.

**NOTE:** Set the economy control switch to the 'OFF (O)' position.

1. Disconnect any electric devices.
2. Turn the Stop/Run/Start Engine Switch to the 'STOP' position.



3. Hold the Fuel Tank Cap and turn the fuel tank vacuum relief valve knob to the 'OFF' position.



**NOTE:** Be sure the Stop/Run/Start Engine Switch and the Fuel Tank Vacuum Relief Valve are in the 'STOP' and 'OFF' positions when stopping, transporting and storing the generator.



# MAINTENANCE

## ENGINE OIL (EVERY 100 HOURS OR 6 MONTHS OF USE)



**CAUTION: PROLONGED EXPOSURE TO USED ENGINE OIL IS DANGEROUS, ALWAYS WASH YOUR HANDS THOROUGHLY AFTER HANDLING USED ENGINE OIL.**

1. Remove the access panel located on the side of the generator by unscrewing the two screws at the top.



2. Turn the oil filler cap anti-clockwise and remove from the oil tank.
3. Tilt the generator to allow the oil to drain out of the oil reservoir into a suitable container via the drain channel.

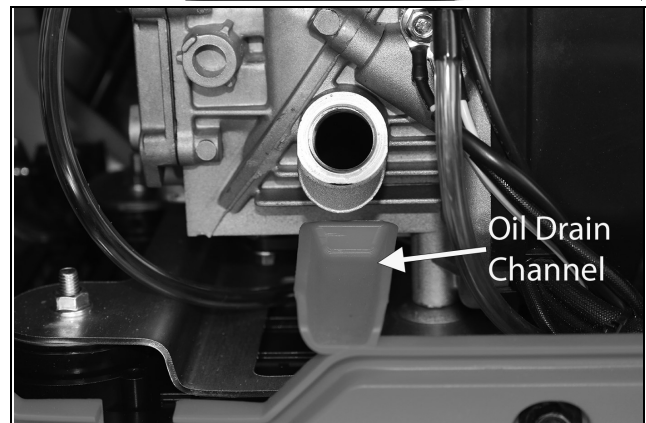

**NOTE:** You may need assistance with this step as the generator is heavy.

4. Once empty of old oil, fill the oil reservoir with fresh oil.
  - **DO NOT** fill above the max level mark (0.15 litres)
  - We recommend the use of SAE 10W-30 oil in this generator. (CLARKE part number 3050845)
5. Replace the oil filler cap and maintenance panel.

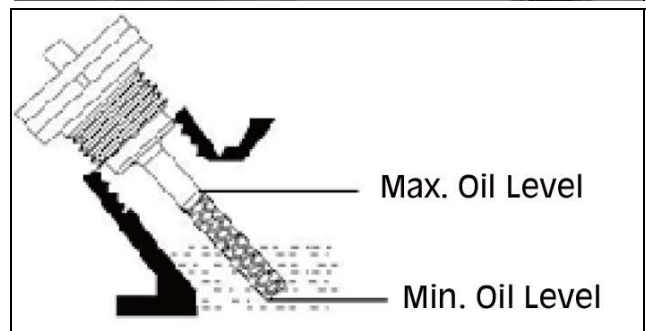

## ENVIRONMENTAL PROTECTION

One of the most damaging sources of pollution is oil. **DO NOT** throw away used engine oil in with your domestic waste or down drains and sinks. Place it in a leak proof container and dispose of it according to local regulations.

## AIR FILTER (EVERY 50 HOURS OR 3 MONTHS OF USE)



**WARNING: DO NOT USE FLAMMABLE SOLVENTS OR PETROL TO CLEAN THE AIR FILTER.**

1. Remove the access panel located on the side of the generator by unscrewing the two screws at the top.



2. Remove the air filter cover screw.
3. Remove the air filter cover.

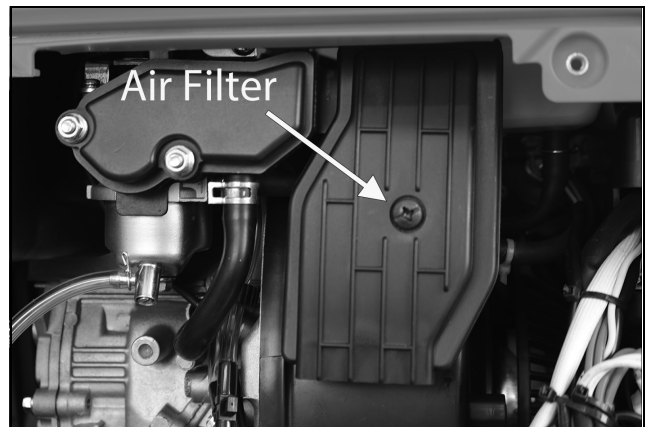

4. Remove the air filter element.
5. If the air filter is damaged contact the CLARKE spare parts department for a replacement.

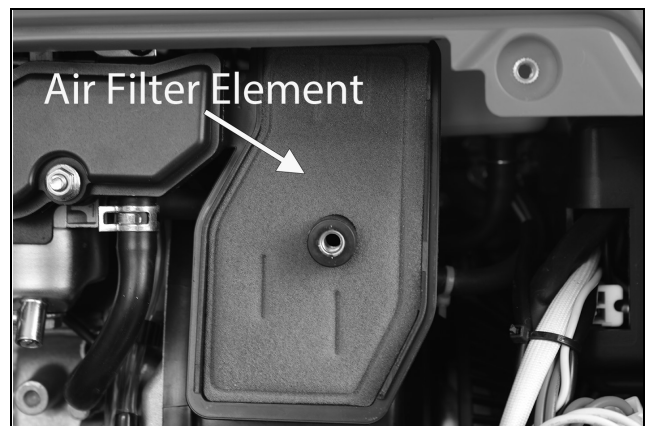

- If the filter is dirty, wash it in a solution of warm water and mild detergent and then rinse thoroughly.
  - Leave the filter to dry completely, once it is dry immerse the filter in clean engine oil and squeeze the filter to remove excess oil.
6. Replace the filter into its original position and replace and secure the air filter cover.

## SPARK PLUG (EVERY 300 HOURS OR 2 YEARS OF USE)



**CAUTION: ALLOW THE ENGINE TO COOL BEFORE REMOVING THE SPARK PLUG.**

1. Slide out the spark plug cover panel located on top of the generator.

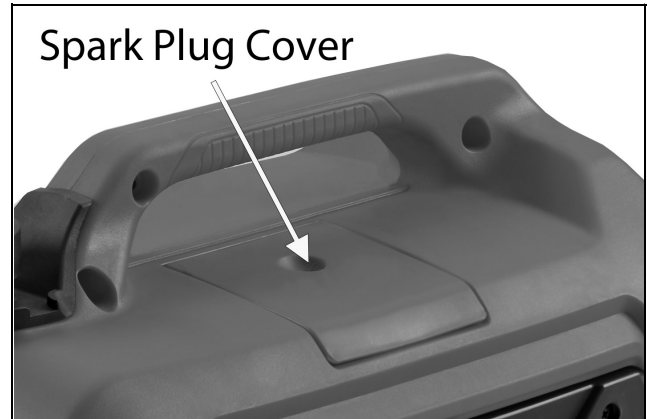

2. Remove the spark plug cap from the spark plug.

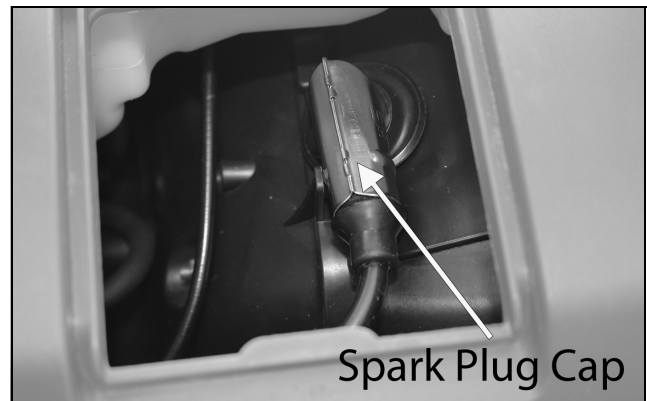

3. Fit the spark plug box spanner over the spark plug as shown.

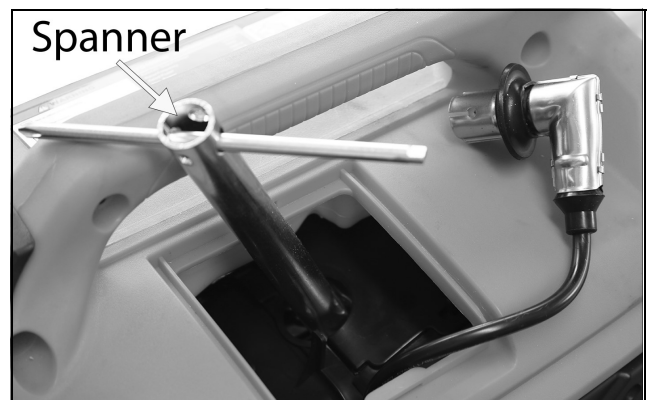

4. When the spark plug has been removed, check for discoloration and use a wire brush to remove any carbon build up.

5. Check the spark plug gap (a) with a feeler gauge, it should be between 0.6 and 0.7 mm.

- Adjust if necessary.

6. Check the overall condition of the spark plug and replace if damaged.

**NOTE:** Spark plugs are available from CLARKE Spare Parts department 020 8988 7400.

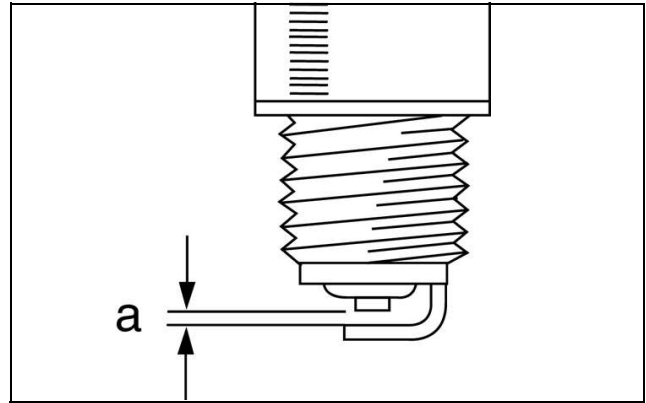

7. Reinstall the spark plug and replace the spark plug cap and cover.

## **CLEAN FUEL TANK FILTER (EVERY 2 YEARS OF USE)**

Just inside the fuel tank is a fuel filter, check this filter periodically and remove any contaminants which may have accumulated.

1. Remove the fuel tank cap.
2. Lift out the filter inside.

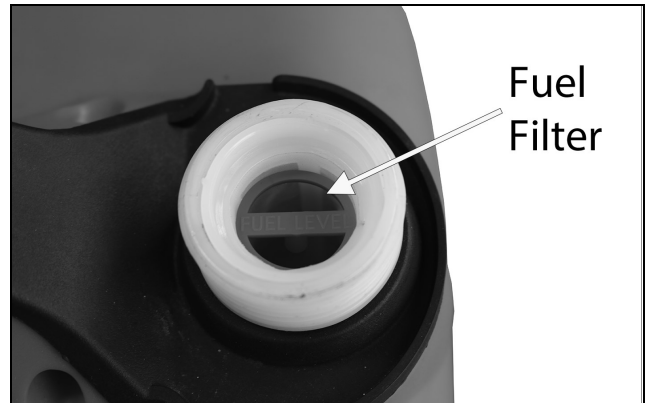

3. Clean the filter with solvent. If the filter is damaged, contact CLARKE Spare Parts department 020 8988 7400 for a replacement.
4. Replace the filter and fuel tank cap.



**CAUTION: ALLOWING PETROL TO SIT IN A FUEL TANK FOR LONG PERIODS OF TIME CAN MAKE IT DIFFICULT TO START THE GENERATOR IN THE FUTURE. NEVER STORE THE GENERATOR FOR EXTENDED PERIODS OF TIME WITH FUEL IN THE TANK.**

# TROUBLESHOOTING

## WHEN THE ENGINE CAN NOT BE STARTED

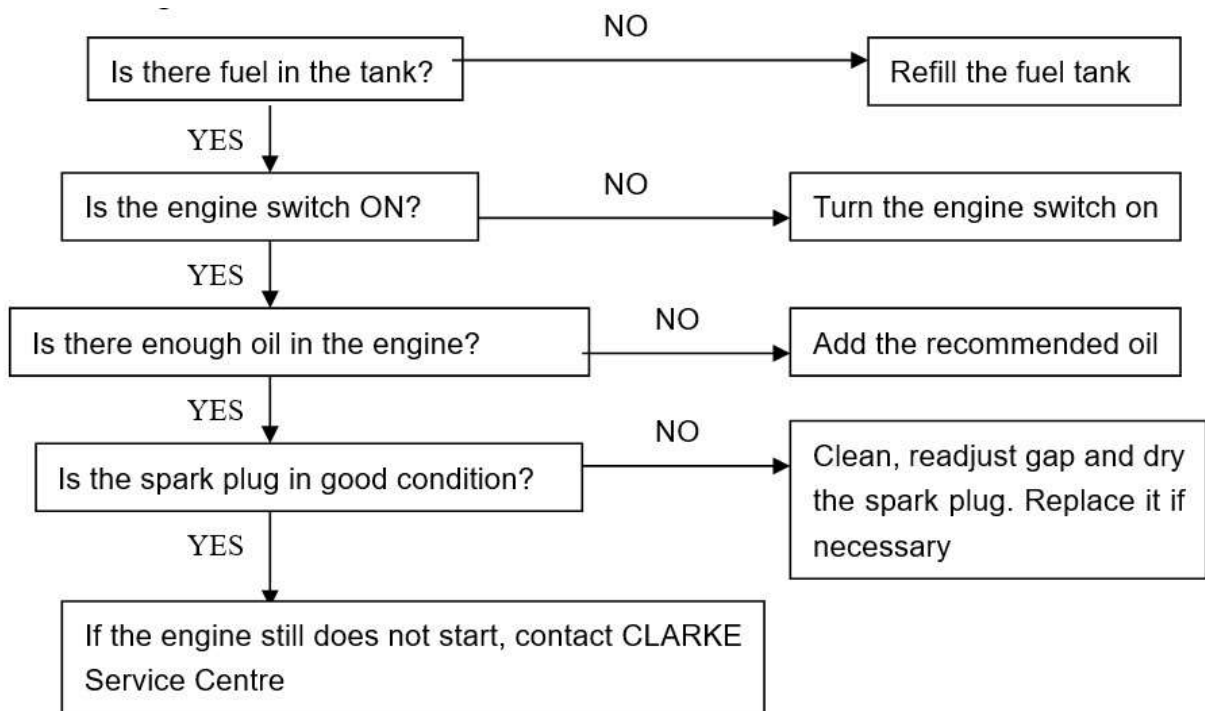

## APPLIANCE DOES NOT OPERATE

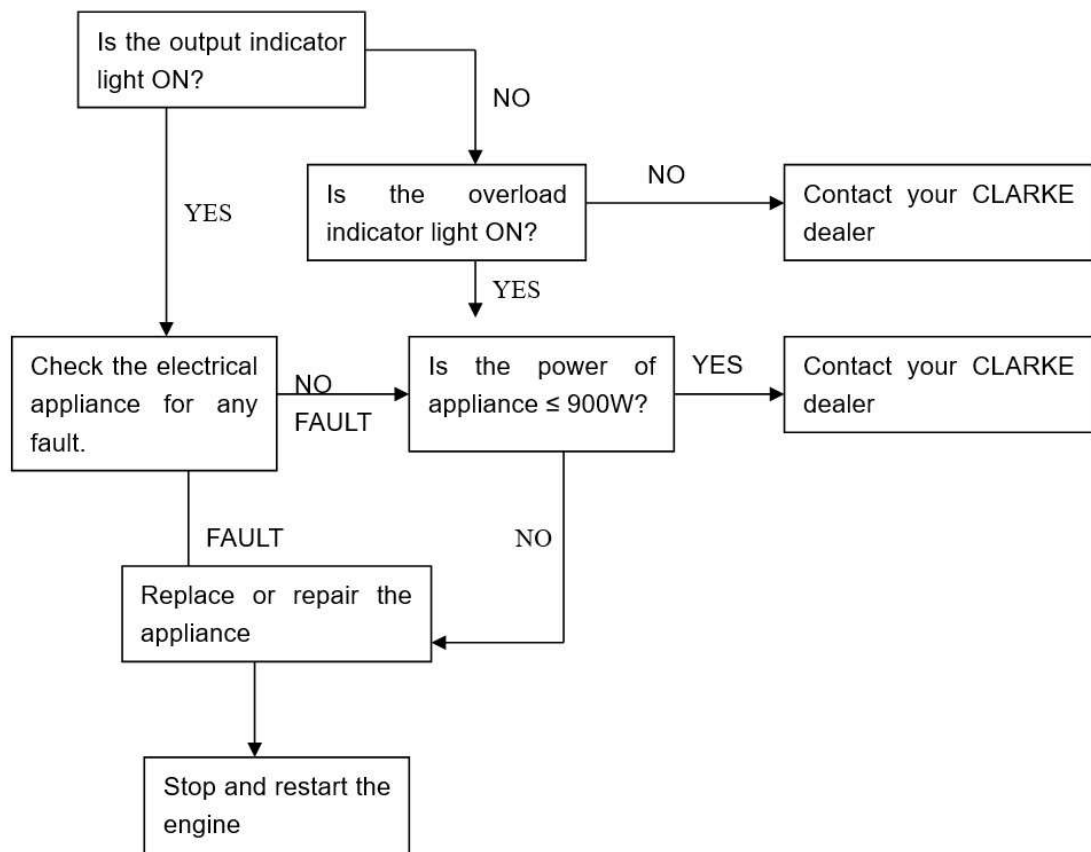

## DC RECEPTACLE WITHOUT ANY ELECTRICITY

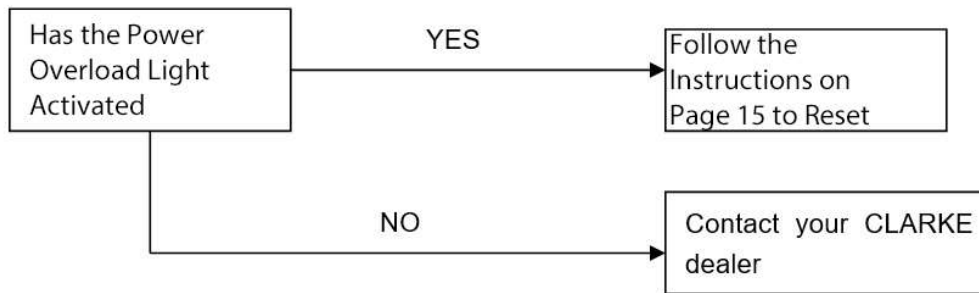

If these do not solve your problem, please contact the CLARKE service department. see below.

# EXPLODED DIAGRAM - ENGINE

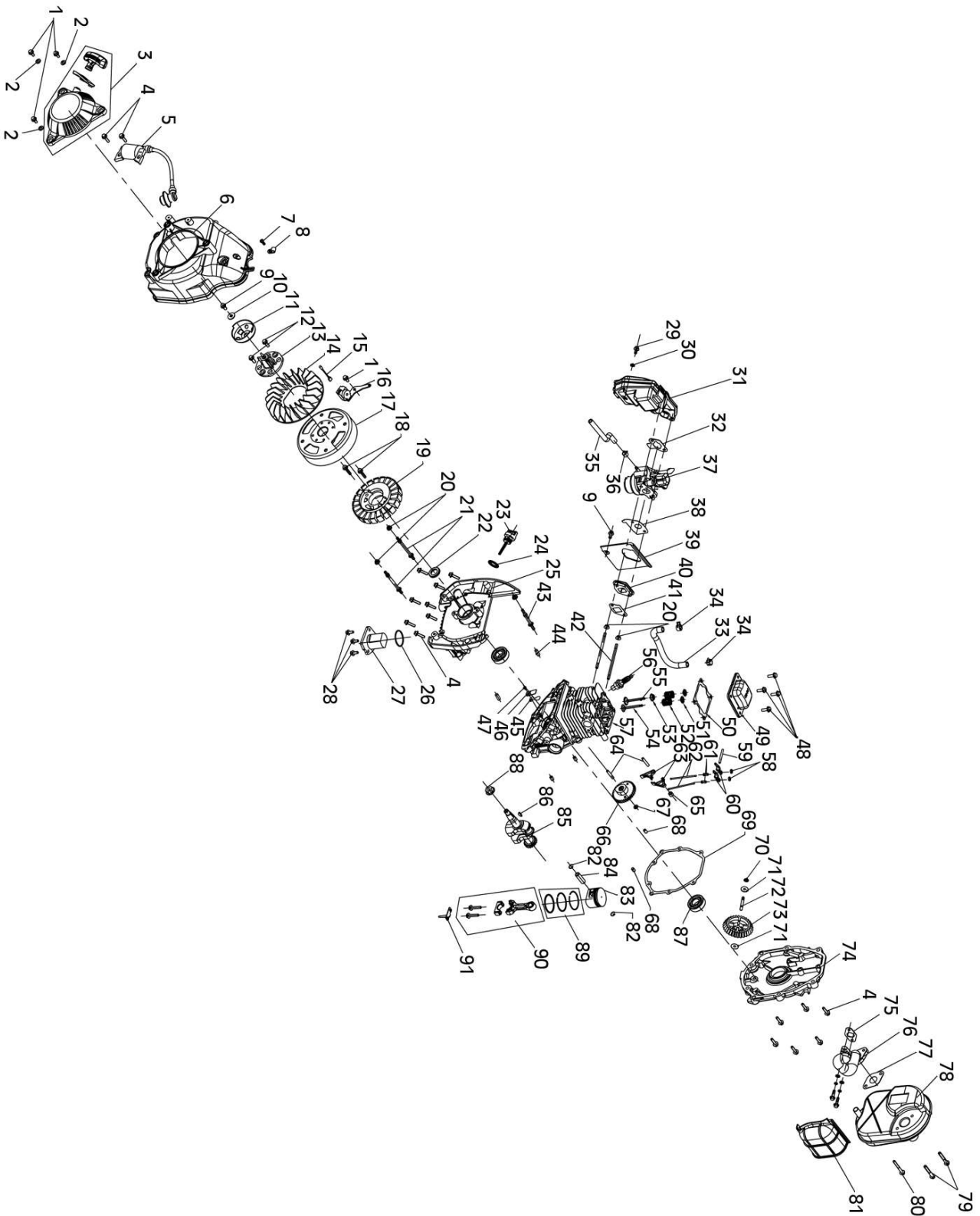

## PARTS LIST - ENGINE

No	Description	No	Description
1	Flange Bolt M5 x 12	24	Oil Scale Gasket
2	Gasket	25	Lower Crankcase
3	Recoil Starter	26	Oil Sensor O Sealing Ring
4	Flange Bolt M5 x 20	27	Oil Sensor
5	High Voltage Transformer	28	Flange Bolt M5 x 12
6	Fan Cover	29	Flange Bolt M5 x 12
7	Line Cord Bolt	30	Gasket 5 x 14 x 1
8	Line Cord Flange	31	Air Filter
9	Flange Bolt	32	Air Filter Gasket
10	Gasket 6.5 x 17.6 x 1.5	33	Crankcase Gasket
11	Starting Cup	34	Circlip 12.5
12	Flange Bolt M5 x 12	35	Fuel Pipe
13	Starting Cup Base	36	Circlip 10
14	Fan	37	Carburetor
15	Tie	38	Carburetor Gasket
16	Trigger	39	Heat Shield
17	Rotor	40	Air Intake Tower
18	Flange Bolt M5 x 25	41	Intake Gasket
19	Stator	42	Carburetor Double End Studs
20	Flange Nut M5	43	Double End Studs
21	Double End Studs	44	Pin 6 x 15
22	Oil Seal	45	Breathing Plate
23	Oil Scale	46	Breathing Plate Pressure Plate



47	Bolt M3 x 6	70	Circlip 3
48	Flange Bolt M5 x 12	71	Jilt Oil Gear
49	Cylinder Head Cover	72	Jilt Oil Gear Shaft
50	Cylinder Head Gasket	73	Gasket
51	Spring Upper Retainer	74	Crankcase Cover
52	Exhaust Valve	75	Exhaust Pipe Gasket
53	Valve Oil Seal	76	Exhaust Pipe
54	Exhaust Valve	77	Muffler Gasket
55	Intake Valve	78	Muffler
56	Spark Plug	79	Muffler Bolt 1
57	Upper Crankcase	80	Muffler Bolt 2
58	Adjusting Nut	81	Muffler Plate
59	Rocker Arm Shaft	82	Piston Circlip
60	Upper Rocker Arm Shaft	83	Piston
61	Adjusting Bolt	84	Piston Pin
62	Push Rod	85	Crankshaft
63	Lower Rocker Arm	86	Woodruff Key
64	Lower Rocker Arm Shaft	87	Bearing
65	Shaft Sleeve	88	Flywheel Nut M10 x 1.25
66	Cam	89	Piston Ring
67	Gasket	90	Connecting Rod
68	Pin	91	Jilt Oil Plate
69	Crankcase Cover Gasket		

# EXPLODED DIAGRAM - GENERAL

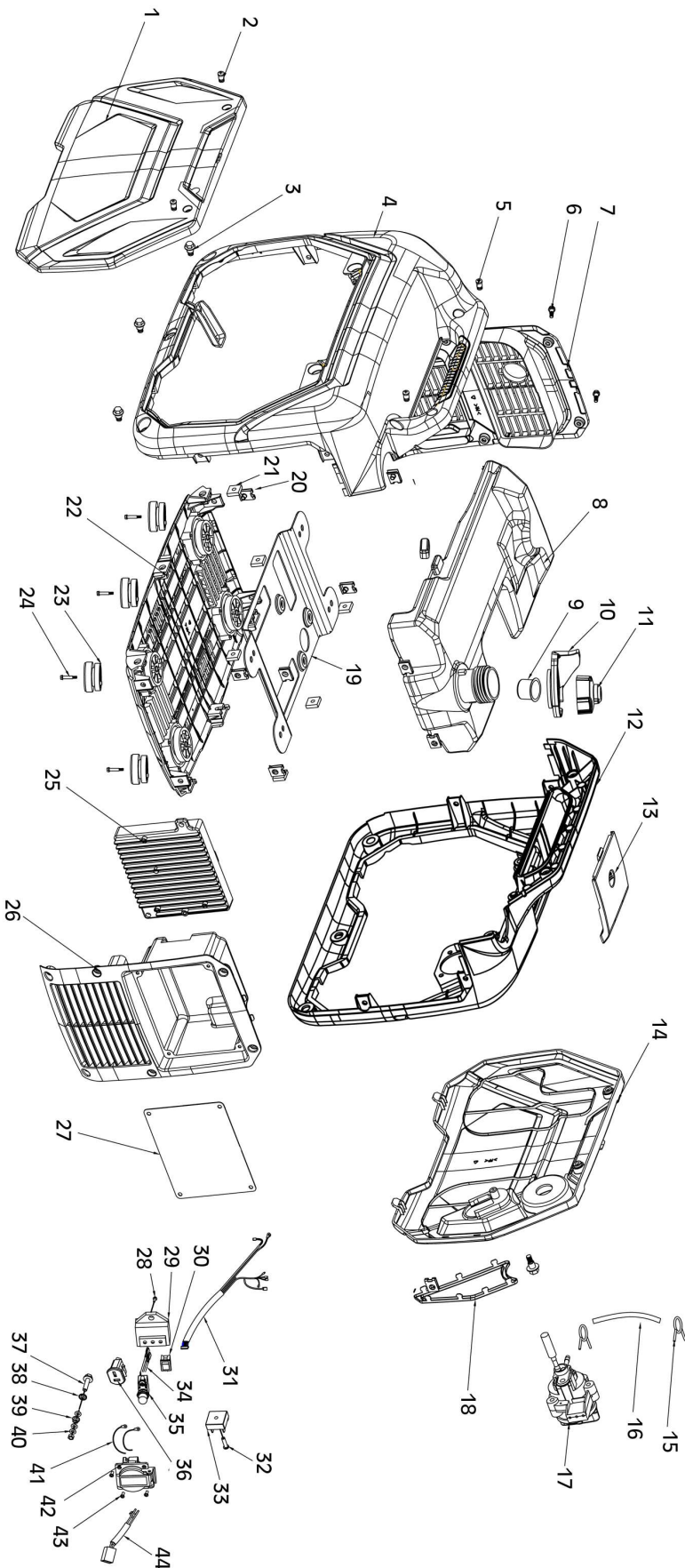

## PARTS LIST - GENERAL

<b>No</b>	<b>Description</b>	<b>No</b>	<b>Description</b>
1	Right Side Cover	23	Rubber Feet
2	Trim Bolt	24	Rubber Foot Fixing Bolt
3	Skeleton Step Fixing Bolt	25	Inverter
4	Right Frame	26	Panel Cover
5	Skeleton Bolt	27	Panel
6	Muffler Housing Fixing Bolts	28	M5 Screw
7	Muffler Housing	29	M5 Screw Card
8	Fuel tank	30	3 in 1 Igniter
9	Fuel Filter	31	3 in 1 Igniter Wiring Harness
10	Fuel tank Opening Pad	32	Bridge Pile Fixing Bolt
11	Fuel Tank Cap	33	Bridge Pile
12	Left Frame	34	DC Breaker Cable
13	Spark Plug Maintenance Cover	35	DC Breaker + Waterproof Cap
14	Left Side Cover	36	T Model Socket
15	Fuel Pipe Clip	37	Grounding Bolt
16	Fuel pipe	38	Gear Gasket
17	3 in 1 Oil Switch	39	Spring Washers 6
18	Recoil Starter Cover	40	Nut M6
19	Engine Floor	41	AC Socket Line
20	M5 Screw Card	42	AC Socket
21	Square Nut M6	43	Socket Fixing Bolt
22	Floor	44	DC Line

# WIRING DIAGRAM - ENGINE

## Engine Diagram

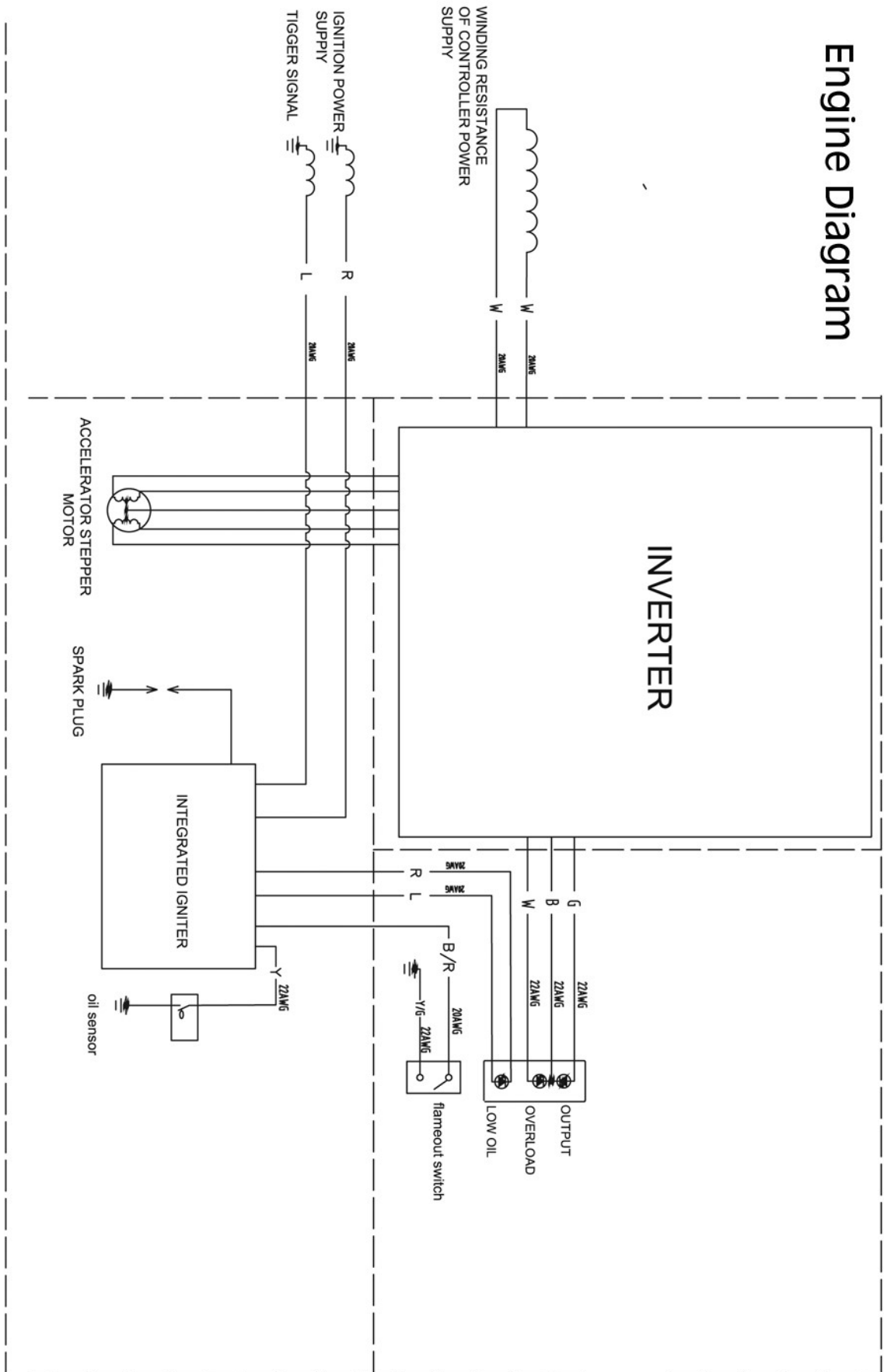

# WIRING DIAGRAM - GENERAL

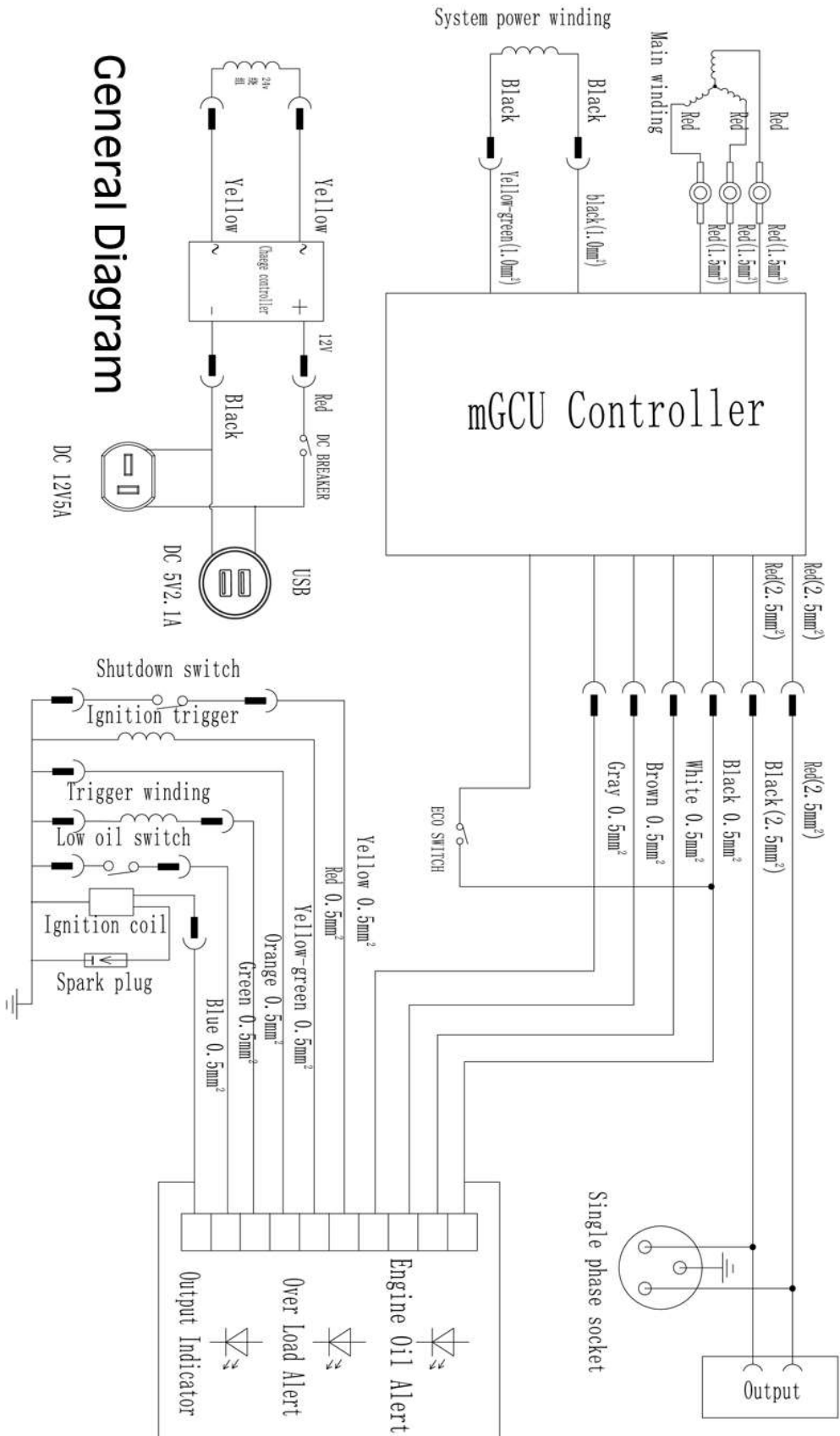

General Diagram

# DECLARATION OF CONFORMITY -UKCA



## DECLARATION OF CONFORMITY

This is an important document and should be retained.

We hereby declare that this product(s) complies with the following legislation: The following standards have been applied to the product(s):

- Noise Emission in the Environment by Equipment for use Outdoors Regulations 2001 IEC 62321-4:2013+AMD1:2017 CSV, EN IEC 61000-6-1:2019, EN ISO 8528-13:2016,
- The Electromagnetic Compatibility Regulations 2016 IEC 62321-6:2015, IEC 62321-8:2017, EN ISO 3744:1995, IEC 62321-7-2:2017,
- The Supply of Machinery (Safety) Regulations 2008 IEC 62321-1:2013, IEC 62321-2:2013, IEC 62321-5:2013, IEC 62321-7-1:2015,
- The Non-Road Mobile Machinery (Type-Approval and Emission of Gaseous and Particulate Pollutants) Regulations 2018 EN 55012:2007+A1, IEC 62321-3-1:2013, ISO 8528-10:1998, ISO 17075:2017
- The Restriction of the Use of Certain Hazardous Substances in Electrical and Electronic Equipment Regulations 2012

The technical documentation required to demonstrate that the product(s) meet(s) the requirement(s) of the aforementioned legislation has been compiled and is available for inspection by the relevant enforcement authorities.

The UKCA mark was first applied in: 2024

<b>Manufacturer:</b>	Clarke International Ltd, Hemmell Street, Epping, Essex, CM16 4LG, United Kingdom	<b>Notified Body:</b>	TÜV Rheinland LGA Products GmbH (ID Number: 0197), Tillystraße 2, 90431 Nürnberg, Germany
<b>Product Description:</b>	Inverter Generator	<b>Assessment Procedure:</b>	Annex VI of above noise legislation
<b>Model Number(s):</b>	IG1100	<b>Measured LWA:</b>	91.8 dB
<b>Serial/Batch Number:</b>	Refer to product/packaging label	<b>Guaranteed LWA:</b>	93 dB
<b>Document Holder:</b>	Alan Pond	<b>Signed:</b>	 J.A. Clarke Director
<b>Date of Issue:</b>	23/04/2024		

IG1100 UKCA Clarke DOC 042324

Page 1 of 1

# DECLARATION OF CONFORMITY - CE



## DECLARATION OF CONFORMITY

This is an important document and should be retained.

We hereby declare that this product(s) complies with the following legislation: The following standards have been applied to the product(s):

2000/14/EC	Outdoor Noise Directive	IEC 62321-4:2013+AMD1:2017 CSV, EN IEC 61000-6-1:2019, EN ISO 8528-13:2016,
2014/30/EU	Electromagnetic Compatibility Directive	IEC 62321-6:2015, IEC 62321-8:2017, EN ISO 3744:1995, IEC 62321-7-2:2017,
2006/42/EC	Machinery Directive	IEC 62321-1:2013, IEC 62321-2:2013, IEC 62321-5:2013, IEC 62321-7-1:2015,
2016/1628	Particulate Emission and Type-Approval for Non-Road Mobile Machinery Regulation	EN 55012:2007+A1, IEC 62321-3-1:2013, ISO 8528-10:1998, ISO 17075:2017
2011/65/EU	Restriction of Hazardous Substances (RoHS) Directive	

The technical documentation required to demonstrate that the product(s) meet(s) the requirement(s) of the aforementioned legislation has been compiled and is available for inspection by the relevant enforcement authorities.

The CE mark was first applied in: 2024

<b>Manufacturer:</b>	Clarke International Ltd, Fitzwilliam Hall, Fitzwilliam Place, Dublin 2, Republic of Ireland	<b>Notified Body:</b>	TÜV Rheinland LGA Products GmbH (ID Number: 0197), Tillystraße 2, 90431 Nürnberg, Germany
<b>Product Description:</b>	Inverter Generator	<b>Assessment Procedure:</b>	Annex VI of above noise legislation
<b>Model Number(s):</b>	IG1100	<b>Measured LWA:</b>	91.8 dB
<b>Serial/Batch Number:</b>	Refer to product/packaging label	<b>Guaranteed LWA:</b>	93 dB
<b>Document Holder:</b>	Alan Pond	<b>Signed:</b>	
<b>Date of Issue:</b>	23/04/2024		J.A. Clarke Director

IG1100 CE Clarke DOC 042324

Page 1 of 1

# A SELECTION FROM THE VAST RANGE OF

# Clarke®

## QUALITY PRODUCTS



**AIR COMPRESSORS**  
From DIY to industrial, Plus air tools, spray guns and accessories.

**GENERATORS**  
Prime duty or emergency standby for business, home and leisure.

**POWER WASHERS**  
Hot and cold, electric and engine driven - we have what you need

**WELDERS**  
Mig, Arc, Tig and Spot. From DIY to auto/industrial.

**METALWORKING**  
Drills, grinders and saws for DIY and professional use.

**WOODWORKING**  
Saws, sanders, lathes, mortisers and dust extraction.

**HYDRAULICS**  
Cranes, body repair kits, transmission jacks for all types of workshop use.

**WATER PUMPS**  
Submersible, electric and engine driven for DIY, agriculture and industry.

**POWERTOOLS**  
Angle grinders, cordless drill sets, saws and sanders.

**STARTERS/CHARGERS**  
All sizes for car and commercial use.



## PARTS & SERVICE: 0208 988 7400

**Parts Enquiries**  
[Parts@clarkeinternational.com](mailto:Parts@clarkeinternational.com)

**Servicing & Technical Enquiries**  
[Service@clarkeinternational.com](mailto:Service@clarkeinternational.com)

SALES: UK 01992 565333 or Export 00 44 (0)1992 565335

**Clarke** INTERNATIONAL Hemnall Street, Epping, Essex CM16 4LG  
[www.clarkeinternational.com](http://www.clarkeinternational.com)